

#	DESCRIPTION	PART NUMBER	QTY
1	Collettore #1 / Down pipe #1	9773K044S2A	1
2	Collettore #2 / Down pipe #2	9773K044S2B	1
3	Tubo di raccordo 2-1 / Link pipe 2-1	9773K057S2C	1
4	Tubo di raccordo / Link pipe	9773K057S2D	1
5	Dado M8 flangiato / Flanged nut M8	50.73.393.1	5
6	Vite M8x45 / Screw M8x45	50.73.602.1	1
7	Rondella in alluminio nera / Black aluminium washer	50.73.221.1	1
8	Staffa / Bracket	50.55.1039.0	1
9	Boccola / Bush	50.73.381.1	2
10	Silentblock / Silentblock	50.73.380.1	1
11	Vite M8 x 16 / Screw M8 x 16	50.73.098.1	2
12	Rondella di sicurezza / Safety washer	50.73.604.1	2
13	Silenziatore / Muffler db killer 50.DK.119.0	Delta Race Ø55	1
14	Molla media / Mid-size spring	50.73.359.1	2
15	Molla lunga / Long spring	50.71.080.1	3
16	Tubo in gomma per molla / Rubber pipe for spring	50.73.210.1	5

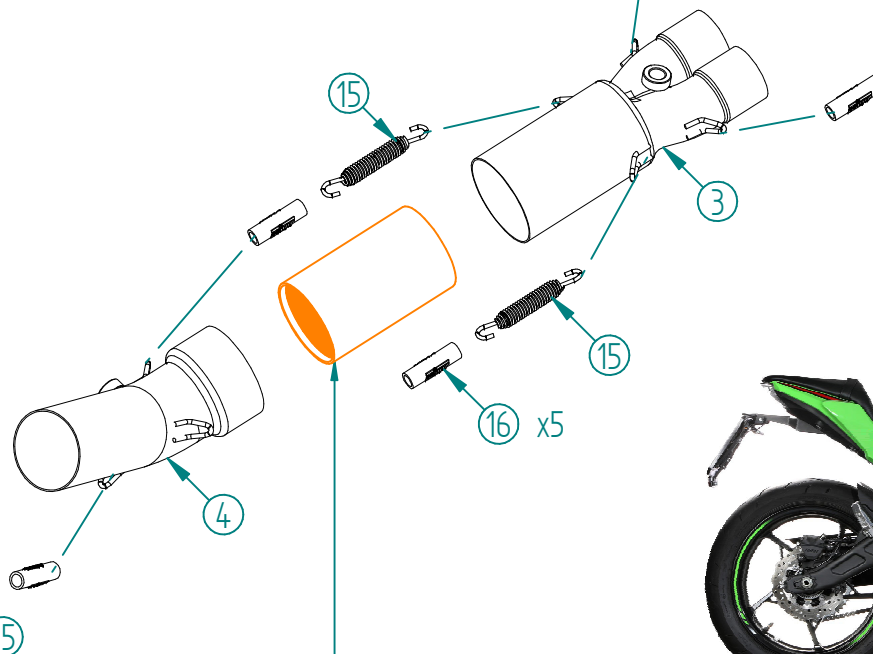

FOTO

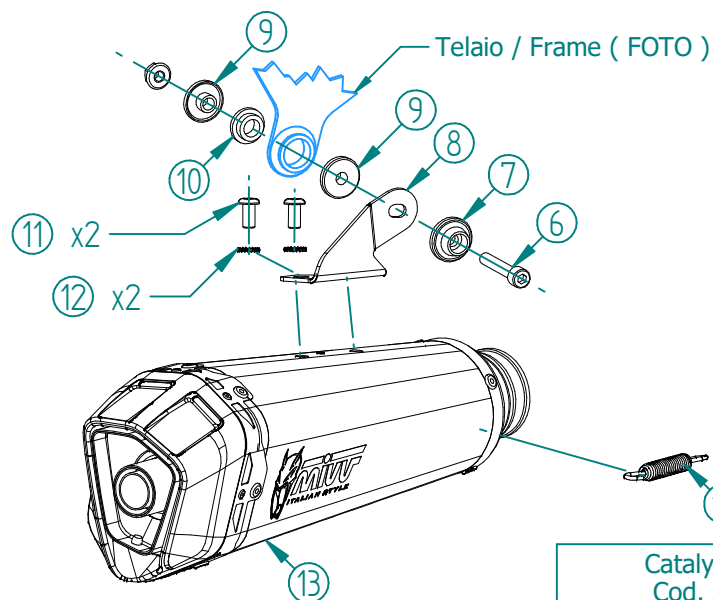

Catalytic Converter
Cod. ACC.094.A1

Optional for K.057.LDRB - K.057.LDRX
Included in K.057.KDRB - K.057.KDRX



APPLICAZIONI / APPLICATIONS			
CODICE / CODE	SILENZIATORE / MUFFLER	NOTE	TUBO / PIPE
K.057.LDRB	STEEL BLACK	CATALYTIC CONVERTER NOT INCLUDED	INOX / ST. STEEL
K.057.LDRX	INOX / ST. STEEL		
K.057.KDRB	STEEL BLACK	CATALYTIC CONVERTER INCLUDED	INOX / ST. STEEL
K.057.KDRX	INOX / ST. STEEL		